

Operating instruction Counting scales/Counting system

KERN CDE/CME/CDEE

Version 1.4

04/2010

GB





KERN CDE/CME/CDEE

Version 1.4 04/2010

Operating instruction

Counting scales/Counting system

Table of Contents

1	Technical data	4
2	Declaration of conformity	8
3	Basic Information (General)	9
3.1	Proper use.....	9
3.2	Improper Use	9
3.3	Warranty	9
3.4	Monitoring of Test Resources.....	9
4	Basic Safety Precautions	10
4.1	Pay attention to the instructions in the Operation Manual	10
4.2	Personnel training	10
5	Transport and storage	10
5.1	Testing upon acceptance	10
5.2	Packaging.....	10
6	Unpacking, Setup and Commissioning	10
6.1	Installation Site, Location of Use.....	10
6.2	Unpacking	11
6.2.1	Placing.....	11
6.2.2	Scope of delivery	11
6.2.3	Assembly instructions for the use of a tripod (KERN CDE only, optional).....	12
6.3	Mains connection	13
6.4	Operation using a (rechargeable) battery (optional)	13
6.5	Connection of peripheral devices.....	13
6.6	Initial Commissioning	13
6.7	Adjustment.....	14
6.8	Adjustment.....	14
7	Operation	15
7.1	Overview of display.....	15
7.2	Keyboard overview.....	15
7.3	Weighing	16
7.4	Taring.....	16
7.5	PRETARE - Function.....	16
7.6	Plus/minus weighings.....	17
7.7	Parts counting	17
7.7.1	Automatic reference optimization.....	18
7.8	Percent weighing.....	18

8	The menu	19
8.1	Invoke menu.....	19
8.2	Exit menu	19
8.3	Menu overview.....	20
8.4	Description of individual functions	22
8.4.1	Weighing units (Unit)	22
8.4.2	Backlighting of display (CDE models only)	23
8.4.3	Dosing and Zero-tracking	24
8.4.4	Selection of the adjustment weight.....	25
8.4.5	Reset to factory setting.....	25
9	Data output RS 232 C	26
9.1	Technical data.....	26
9.2	Pin allocation of the balance output socket (front view)	26
9.3	Interface parameter	26
9.3.1	Data transfer mode.....	26
9.3.2	Baud rate	27
9.3.3	Selection printed edition	27
9.4	Explanation of the data transfer	28
9.4.1	AU PC.....	29
9.5	Output on bar code printer	31
10	Service, maintenance, disposal	32
10.1	Cleaning	32
10.2	Service, maintenance.....	32
10.3	Disposal.....	32
11	Instant help	33
12	Counting system CDEE	34
12.1	Introduction.....	34
12.2	Technical data.....	34
12.3	Basic structure	34
12.4	Installation.....	35
12.5	Balance settings	35
12.6	Counting with both scales	35

1 Technical data

KERN	CME 100-3	CME 300-2	CME 1000-2
Readability (d)	0,001 g	0,01 g	0,01 g
Weighing range (max)	100 g	300 g	1000 g
Reproducibility	0,001 g	0,01 g	0,01 g
Minimum piece weight	0,002 g	0,02 g	0,02 g
Linearity	± 0,003 g	± 0,02 g	± 0,03 g
Recommended adjustment weight, not included (class) For details on “Selecting an adjustment weight” see chapter 8.4.4	100 g (F 2)	300 g (M 1)	1000 g (F2)
Warming up time (operating temperature)	2 h		
Reference unit weights at piece count	5, 10, 20		
Stabilization time (typical)	2-3 sec		
Electric Supply	300 mA/9V	300 mA/9V	300 mA/9V
Operating temperature	+ 5° C + 35° C		
Humidity of air	max. 80 % (not condensing)		
Weighing platform, synthetic material	Ø 105 mm	Ø 150 mm	Ø 150 mm
Dimensions of the housing (B x D x H)	170 x 240 x 39		
Data interface	RS 232C	RS 232C	RS 232C
Weight kg (net)	0,7	0,7	0,7
Battery operation	9 V- compound battery (optional)		

KERN	CME 3000-1	CME 6000-1
Readability (d)	0,1 g	0,1 g
Weighing range (max)	3000 g	6000g
Reproducibility	0,1 g	0,1 g
Minimum piece weight	0,2 g	0,2 g
Linearity	± 0,2 g	± 0,3 g
Recommended adjustment weight, not included (class) For details on “ Selecting an adjustment weight “ see chapter 8.4.4	3000 g (M 1)	6000 g (M 1)
Warming up time (operating temperature)	2 h	
Reference unit weights at piece count	5, 10, 20	
Stabilization time (typical)	2-3 sec	
Electric Supply	300mA/9V	300mA/9V
Operating temperature	+ 5° C + 35° C	
Humidity of air	max. 80 % (not condensing)	
Weighing platform, synthetic material	Ø 150 mm	Ø 150 mm
Dimensions of the housing (B x D x H)	170 x 240 x 39	
Data interface	RS 232C	RS 232C
Weight kg (net)	0,7	0,5
Battery operation	9 V- compound battery (optional)	

KERN	CDE 35K1	CDE 35K1L	CDE 60K2
Readability (d)	1 g	1 g	2 g
Weighing range (max)	35 kg	35 kg	60 kg
Reproducibility	1 g	1 g	2 g
Minimum piece weight	2 g	2 g	4 g
Linearity	3 g	3 g	6 g
Recommended adjustment weight, not included (class) For details on “Selecting an adjustment weight” see chapter 8.4.4	30 kg (F2)	20 kg (F2)	60 kg (F2)
Warming up time (operating temperature)	2 h		
Reference unit weights at piece count	5, 10, 20	5, 10, 20	5, 10, 20
Stabilization time (typical)	2-3 sec		
Electric Supply	DC 9V/300 mA		
Operating temperature	+ 5° C + 35° C		
Humidity of air	max. 80 % (not condensing)		
Weighing plate, stainless steel	315x305x85 mm		
Dimensions of the housing (B x D x H)	Terminal 200 x 100 x 55		
	Platform 315 x 305 x 85		
Data interface	RS 232C		
	----- Connection reference balance		
Weight kg (net)	5	16	5
Battery operation	9 V- compound battery (optional)		
Rechargeable battery (optional)	Working life 15 h with display backlighting/ charging time 10 h		

KERN	CDE 60K2L	CDE 150K5	CDE 150K5L
Readability (d)	2 g	5 g	5 g
Weighing range (max)	60 kg	150 kg	150 kg
Reproducibility	2 g	5 g	5 g
Minimum piece weight	4 g	10 g	10 g
Linearity	6 g	15 g	15 g
Recommended adjustment weight, not included (class) For details on “Selecting an adjustment weight” see chapter 8.4.4	60 kg (F2)	150 kg (F2)	150 kg (F2)
Warming up time (operating temperature)	2 h		
Reference unit weights at piece count	5, 10, 20	5, 10, 20	5, 10, 20
Stabilization time (typical)	2-3 sec		
Electric Supply	DC 9V/300 mA		
Operating temperature	+ 5° C + 35° C		
Humidity of air	max. 80 % (not condensing)		
Weighing plate, stainless steel	315 x 305 x 85 mm		
Dimensions of the housing (B x D x H)	Terminal 200 x 100 x 55		
	Platform 315 x 305 x 85		
Data interface	RS 232C		
	----- Connection reference balance		
Weight kg (net)	16	5	16
Battery operation	9 V- compound battery (optional)		
Rechargeable battery (optional)	Working life 15 h with display backlighting/ charging time 10 h		

2 Declaration of conformity



KERN & Sohn GmbH

D-72322 Balingen-Frommern

Postfach 4052

E-Mail: info@kern-sohn.de

Tel: 0049-[0]7433- 9933-0

Fax: 0049-[0]7433-9933-149

Internet: www.kern-sohn.de

Konformitätserklärung

EC-Konformitätserklärung
 EC- Déclaration de conformité
 EC-Dichiarazione di conformità
 EC- Declaração de conformidade
 EC-Deklaracja zgodności

EC-Declaration of -Conformity
 EC-Declaración de Conformidad
 EC-Conformiteitverklaring
 EC- Prohlášení o shode
 EC-Заявление о соответствии

D	Konformitäts- erklärung	Wir erklären hiermit, dass das Produkt, auf das sich diese Erklärung bezieht, mit den nachstehenden Normen übereinstimmt.
GB	Declaration of conformity	We hereby declare that the product to which this declaration refers conforms with the following standards.
CZ	Prohlášení o shode	Tímto prohlašujeme, že výrobek, kterého se toto prohlášení týká, je v souladu s níže uvedenými normami.
E	Declaración de conformidad	Manifetamos en la presente que el producto al que se refiere esta declaración está de acuerdo con las normas siguientes
F	Déclaration de conformité	Nous déclarons avec cela responsabilité que le produit, auquel se rapporte la présente déclaration, est conforme aux normes citées ci-après.
I	Dichiarazione di conformità	Dichiariamo con ciò che il prodotto al quale la presente dichiarazione si riferisce è conforme alle norme di seguito citate.
NL	Conformiteit- verklaring	Wij verklaren hiermede dat het product, waarop deze verklaring betrekking heeft, met de hierna vermelde normen overeenstemt.
P	Declaração de conformidade	Declaramos por meio da presente que o produto no qual se refere esta declaração, corresponde às normas seguintes.
PL	Deklaracja zgodności	Niniejszym oświadczamy, że produkt, którego niniejsze oświadczenie dotyczy, jest zgodny z poniższymi normami.
RUS	Заявление о соответствии	Мы заявляем, что продукт, к которому относится данная декларация, соответствует перечисленным ниже нормам.

Electronic Scale: KERN CDE, CME

Mark applied	EU Directive	Standards
CE	2004/108/EC	EN 55022: 1998+A1+A2 EN 61000-3-2: 2000+A2 EN 61000-3-3: 1995+A1 EN 55024: 1998+A1+A2

Date: 27.10.2008

Signature: _____

Gottl. KERN & Sohn GmbH
 Management

Gottl. KERN & Sohn GmbH, Ziegelei 1, D-72336 Balingen, Tel. +49-[0]7433/9933-0, Fax +49-[0]7433/9933-149

3 Basic Information (General)

3.1 Proper use

The balance you purchased is intended to determine the weighing value of material to be weighed. It is intended to be used as a “non-automatic” balance, i.e. the material to be weighed is manually and carefully placed in the centre of the weighing plate. As soon as a stable weighing value is reached the weighing value can be read.

3.2 Improper Use

Do not use balance for dynamic weighing. In the event that small quantities are removed or added to the material to be weighed, incorrect weighing results can be displayed due to the “stability compensation” in the balance. (Example: Slowly draining fluids from a container on the balance.)

Do not leave permanent load on the weighing plate. This may damage the measuring system.

Impacts and overloading exceeding the stated maximum load (max) of the balance, minus a possibly existing tare load, must be strictly avoided. Balance may be damaged by this.

Never operate balance in explosive environment. The serial version is not explosion protected.

The structure of the balance may not be modified. This may lead to incorrect weighing results, safety-related faults and destruction of the balance.

The balance may only be used according to the described conditions. Other areas of use must be released by KERN in writing.

3.3 Warranty

Warranty claims shall be voided in case

- Our conditions in the operation manual are ignored
- The appliance is used outside the described uses
- The appliance is modified or opened
- Mechanical damage and damage caused by media, liquids
- Natural wear and tear
- The appliance is improperly set up or incorrectly electrically connected
- The measuring system is overloaded

3.4 Monitoring of Test Resources

In the framework of quality assurance the measuring-related properties of the balance and, if applicable, the testing weight, must be checked regularly. The responsible user must define a suitable interval as well as type and scope of this test. Information is available on KERN’s home page (www.kern-sohn.com) with regard to the monitoring of balance test substances and the test weights required for this. In KERN’s accredited DKD calibration laboratory test weights and balances may be calibrated (return to the national standard) fast and at moderate cost.

4 Basic Safety Precautions

4.1 Pay attention to the instructions in the Operation Manual

Carefully read this operation manual before setup and commissioning, even if you are already familiar with KERN balances.

4.2 Personnel training

The appliance may only be operated and maintained by trained personnel.

5 Transport and storage

5.1 Testing upon acceptance

When receiving the appliance, please check packaging immediately, and the appliance itself when unpacking for possible visible damage.

5.2 Packaging

Keep all parts of the original packaging in case you need to return the appliance.

Only use original packaging for returning.

Before sending, disconnect all connected cables and loose/movable parts.

Attach possibly existing transport safeguards. Secure all parts, e.g. weighing plate, mains adapter etc., to prevent slipping and damage.

6 Unpacking, Setup and Commissioning

6.1 Installation Site, Location of Use

The balances are designed in a way that reliable weighing results are achieved in common conditions of use.

You will work accurately and fast, if you select the right location for your balance.

Therefore, observe the following for the installation site:

- Place the balance on a firm, level surface;
- Avoid extreme heat as well as temperature fluctuation caused by installing next to a radiator or in the direct sunlight;
- Protect the balance against direct draughts due to open windows and doors;
- Avoid jarring during weighing;
- Protect the balance against high humidity, vapours and dust;
- Do not expose the device to extreme dampness for longer periods of time. Non-permitted condensation (condensation of air humidity on the appliance) may occur if a cold appliance is taken to a considerably warmer environment. In this case, acclimatize the disconnected appliance for ca. 2 hours at room temperature.
- Avoid static charge of goods to be weighed and weighing container.

Major display deviations (incorrect weighing results) may be experienced should electromagnetic fields (e.g. due to mobile phones or radio equipment), static electricity accumulations or instable power supply occur. Change location or remove source of interference.

6.2 Unpacking

Carefully remove the balance from the packaging, remove plastic cover and setup balance at the intended workstation.

6.2.1 Placing

The balance must be installed in a way that the weighing plate is exactly in horizontal position.

6.2.2 Scope of delivery

Serial accessories:

Models CME

- Balance
- Mains power supply
- Operating Manual

Models CDE

- Terminal
- Platform
- Mains power supply
- Protective cover
- Operating Manual

6.2.3 Assembly instructions for the use of a tripod (KERN CDE only, optional)

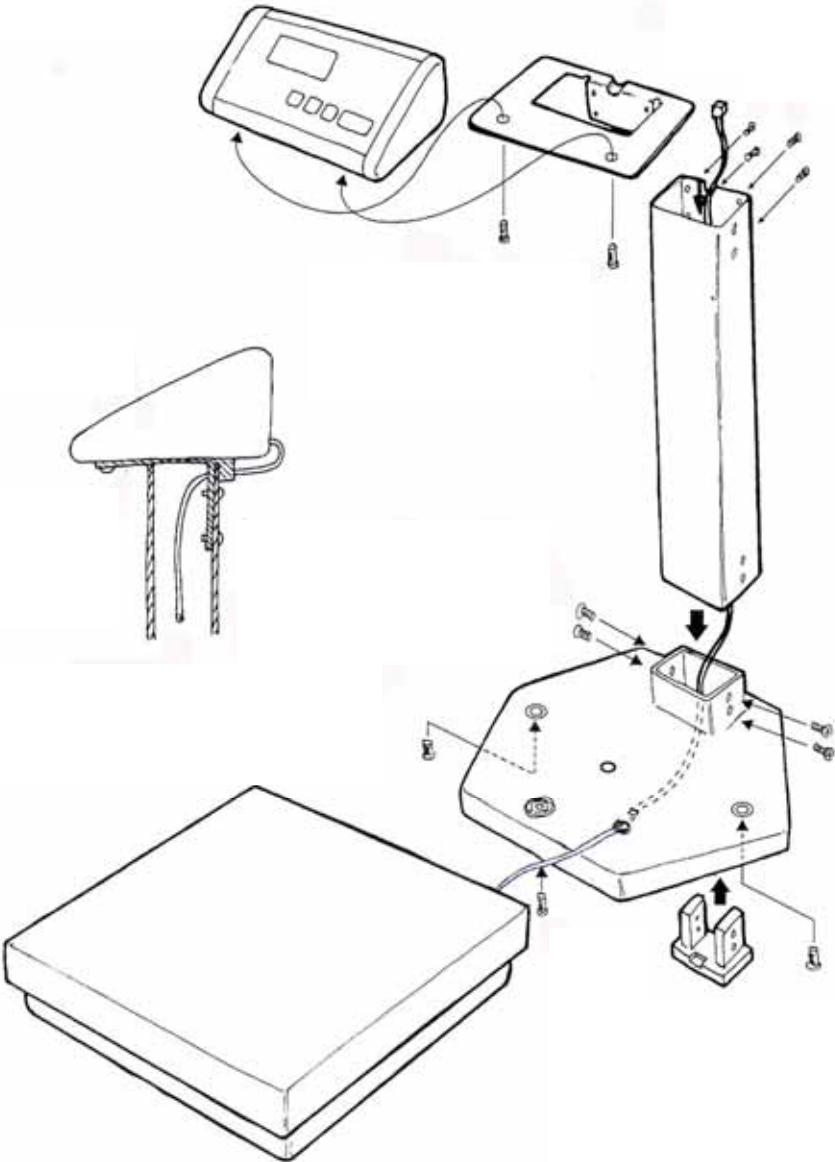

English

6.3 Mains connection

Power is supplied via the external mains adapter. The stated voltage value must be the same as the local voltage. Only use original KERN mains adapters. Using other makes requires consent by KERN.

6.4 Operation using a (rechargeable) battery (optional)

Lift-off the battery compartment cover on the lower side of the balance. Connect 9 V compound battery. Reinsert the battery cover.

For battery operation the balance has an automatic switch-off function which can be activated or deactivated in the menu (chapter 8). Proceed as follows:

- ⇒ With the weighing scale switched off, press **ON/OFF** and **TARE**-key simultaneously until the first function "**Unit**" appears.
- ⇒ Repeatedly press the **10x**-key until "**AF**" appears.
- ⇒ Confirm by pressing the **PRINT**-key. Current setting appears.
- ⇒ Now you can use the **10x**-key to select among the settings below:
 - „**AF on**“: To save the battery, the balance switches off automatically 3 minutes after having finished the weighing procedure.
 - „**AF off**“: Switch-off function deactivated.
- ⇒ Confirm your selected setting by pressing the **PRINT**-key.

Used batteries are indicated by "**LO**" on the display. Press **ON/OFF**-key and replace the batteries immediately.

If the balance is not used for a longer time, take out the batteries and store them separately. Leaking battery liquid could damage the balance.

For **CDE** models the rechargeable battery in the battery compartment has to be connected via a separate plug-in connection. Now the mains adapter delivered with the rechargeable battery must be applied.

6.5 Connection of peripheral devices

Before connecting or disconnecting of additional devices (printer, PC) to the data interface, always disconnect the balance from the power supply.

With your balance, only use accessories and peripheral devices by KERN, as they are ideally tuned to your balance.

6.6 Initial Commissioning

In order to obtain exact results with the electronic balances, your balance must have reached the operating temperature (see warming up time chap. 1). During this warming up time the balance must be connected to the power supply (mains, accumulator or battery).

The accuracy of the balance depends on the local acceleration of gravity. Strictly observe hints in chapter Adjustment.

6.7 Adjustment

As the acceleration value due to gravity is not the same at every location on earth, each balance must be coordinated - in compliance with the underlying physical weighing principle - to the existing acceleration due to gravity at its place of location (only if the balance has not already been adjusted to the location in the factory). This adjustment process must be carried out during the initial start-up, after change in location and variation of surrounding temperature. To receive accurate measuring values it is also recommended to adjust the balance periodically in weighing operation.

6.8 Adjustment

The adjustment should be made with the recommended adjustment weight (see chap. 1 "Technical data"). Adjustment is also possible with the weights of other nominal values (see table 1, chap. 8.4.4), but not the optimum for measuring technique.

Procedure when adjusting:

Observe stable environmental conditions. A warming up time (see chapter 1) is required for stabilization.

- ⇒ Turn on balance by pressing the **ON/OFF** key
- ⇒ Press and keep holding down the  key. In addition press the **ON/OFF**-key at the same time. Keep pressing both keys for 3 s until the display is extinguished.
- ⇒ Let go of both keys. "**CAL**" appears. After that the exact size appears flashing in the display (chapter 8.4.4) of the adjustment weight. Now set the adjusting weight in the centre of the weighing plate.
- ⇒ Confirm by pressing the **PRINT** key Short time later appears „**CAL F**“, then return automatically to the normal weighing mode. In the display there appears the value of the adjustment weight.
- ⇒ An error during adjustment or the use of an incorrect adjusting weight will result in an error message „**CAL E**“. Repeat adjustment.





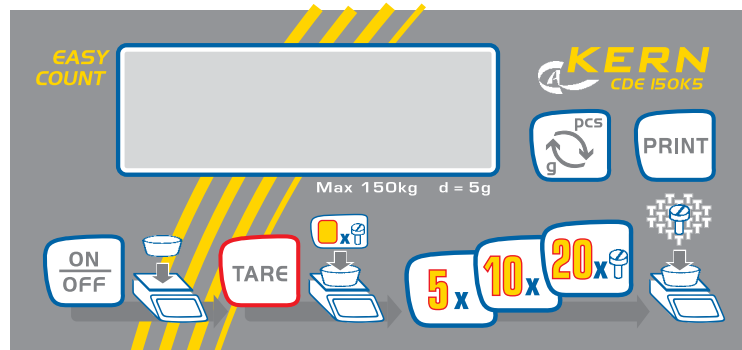

Keep the adjustment close to the balance. Daily control of the weighing exactness is recommended for quality-relevant applications.

7 Operation

7.1 Overview of display



7.2 Keyboard overview

	In weighing mode:	In menu
	ON/OFF	
	Taring	Use the ON/OFF key and activate the Mode Menu.
	Configuration of reference using 5 parts	
	Configuration of reference using 10 parts	Function selection Parameter selection
	Configuration of reference using 20 parts	
	Switchover pcs ↔ g	NO-function
	Print weighing result.	Save/acknowledge YES-function

7.3 Weighing

⇒ Turn on balance by pressing the **ON/OFF** key. The balance shows for approx. 3 seconds „88888“ in the display and then goes to „0“. Now it is ready for operation.

Important: Should the display flash or not be on „0“, press the TARE button.

⇒ Only now (!) place goods onto weighing plate. Take care that the weighed material does not touch the balance housing or the base mat.

⇒ Now the weight is displayed, after the standstill control appears the weighing unit (e.g. g or kg) right-hand in the display.

If the material to be weighed is heavier than the weighing range, the display will show "**Error**" (=Overload).

7.4 Taring

⇒ Switch-on the balance using the **ON/OFF** key and wait for the „0“ display.

⇒ Place the tare vessel on the weighing plate and press the **TARE** button. The balance display goes to „0“. The weight of the container is now internally saved.

⇒ If after finishing the weighing process the **TARE** button is pressed again, „0“ appears anew in the display.

The taring process can be repeated any number of times, e.g. when adding several components for a mixture (adding).

The limit is reached when the whole weighing range is exhausted.

After removing the taring container the total weight is displayed as negative display.

7.5 PRETARE - Function

Using this function the weight of a tare vessel can be stored.

This value also remains saved if the balance meanwhile has been switched off and switched on again.

1. In weighing mode, place the taring vessel on the weighing platform, keep pressing the **ON/OFF**- and **TARE**-key until the display is extinguished.
2. Let go of both keys, "**PRETARE**" will pop up briefly on the display. The current weight on the weighing platform is now being stored as PRETARE weight. The balance returns automatically into weighing mode.

After removing the taring container the total weight is displayed as negative display. If required, put the weighing scale display back to zero by pressing the **TARE**-key.

To delete the tare value in the memory, follow step 1 and 2 without the use of a taring vessel.

7.6 Plus/minus weighings

For example unit weight control, fabrication control etc.

- ⇒ In weighing mode, place target weight on weighing platform and tare to “0” by pressing the **TARE**-key. Remove the nominal weight.
- ⇒ Put the test objects subsequently on the weighing plate, the respective deviation from the nominal weight is displayed with the respective sign to „+“ and „-“.

According to the same procedure also packages with the same weight can be produced, referring to a nominal weight.

Back to weighing mode by pressing the **TARE** button.

7.7 Parts counting

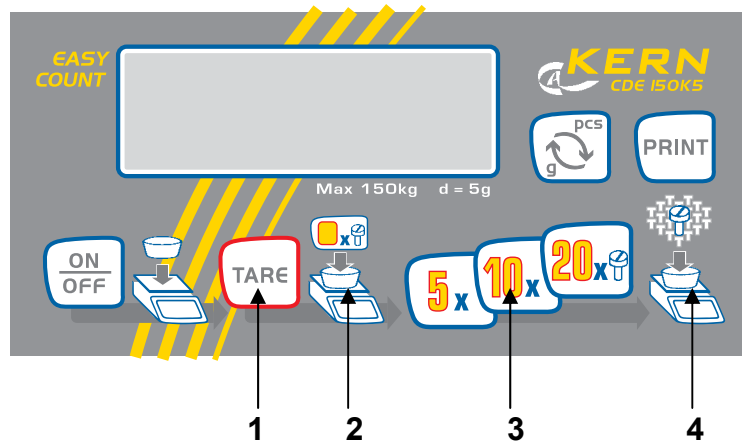

1. Place empty vessel on weighing platform and tare by pressing the key (TARE)
2. Fill vessel with reference piece number of count quantity (e.g. 5, 10, 20 items)
3. Confirm reference piece number by pressing the key (5, 10, 20). Remove reference weight. The balance is now in parts counting mode counting all units on the weighing plate.
4. Fill with count quantity. The piece number is shown directly on the display.

By pressing the  button the balance returns to the weighing mode and displays the weight of the counted units.

Important: The larger the reference quantity, the more accurate the parts counting.

For minimum count weight see table “**Specifications**“. If weight falls short of this, “**Error**“ will be shown on the display and the weighing scale will return automatically to weighing mode.

7.7.1 Automatic reference optimization

To do this, the function “**OPTi**” has to be enabled (**on**) in the menu, see chpt. 8.

- ⇒ Enter reference weight (see chpt. 7.7)
- ⇒ The reference weight is recalculated each time new additional items are placed on the weighing platform (up to 100 pieces only). As the additional pieces increase the base for the calculation, the reference also becomes more exact.

7.8 Percent weighing

Percent weighing allows to display weight in percent, in relation to a reference weight.

- ⇒ Turn on balance by pressing the **ON/OFF** key
- ⇒ Put reference item on weighing plate
- ⇒ Press **ON/OFF** key and **PRINT** key and keep them pressed until the display extinguishes
- ⇒ Release both buttons, the weight of the item is taken over as reference (100%).
- ⇒ Now you can place the test objects onto the weighing plate; the percentage is displayed

8 The menu



8.1 Invoke menu

- ⇒ With the weighing scale switched off, press **ON/OFF** and **TARE**-key simultaneously until the first function "**Unit**" appears.
- ⇒ Select function by pressing the **10x**-key.
Confirm selected function by pressing the **PRINT**-key; current setting appears.
- ⇒ Parameters are selected by pressing the **10x**-key.
Store selected parameters by pressing the **PRINT**-key; weighing balance automatically returns to weighing mode.

8.2 Exit menu

Everywhere in the menu it is possible to leave the menu and thereby save or reject the changes made.

After pressing the **TARE** button „**Exit**“ is displayed.

- A) Confirm by pressing the **PRINT**-key (yes). After that „**store**“ is displayed. If it shall be saved, press the **PRINT** button repeatedly.
If you wish to exit the menu without storing press the  key (no).
- B) The  (NOT EXIT) button must be pressed, if the next menu item shall be reached. After having set all the individual adjustments, it can be saved.

8.3 Menu overview

Description of function	Function	Parameter	Description of options
Weighing unit switchover (see chpt. 8.4.1)	UNIT	g	Gram
		kg	Kilogram (model-dependent)
		oz	Pound
		ozt	Ounce
		lb	Troy ounce
		tlh	Tael Hongkong
		tlt	Tael Taiwan
		gn	Grain (model-dependent)
		dwt	Pennyweight (model-dependent)
		mo	Momme
		Tol	Tola
		ct	Carat (model-dependent)
FFA	Freely selectable factor		
Data transfer mode (see chpt. 9.3.1)	PR	rE CR	Data output via remote control commands (see chpt. 9.4.4)
		Pr PC	Data output by pressing the PRINT-key (see chpt. 9.4.1)
		AU PC	Continuous data output (see chpt. 9.4.3)
		bA Pr	Output to barcode printer (see chpt. 9.4.5)
		CSYS (CME only)	Mode for counting system: Autom. adoption of reference weight by CDE from CME
		AU Pr	Autom. data output of stable weighing values (see chpt. 9.4.2)
Selecting print output (see chpt. 9.3.3)	LAPr	Hdr	Edition of the headlines
		GrS	Edition of the total weight
		Net	Edition of the net weight
		tAr	Edition of the tare weight
		N7E	Edition of the stored weight
		PCS	Edition of quantity
		AUJ	Edition of the unit weight
		Rqt	Edition of the reference quantity
		FFd	Edition of a page feeding
		FFE	Edition of a page feeding at end printer output

Baud rate (see chpt. 9.3.2)	bAUd	19200	
		9600	
		4800	
		2400	
		1200	
AUTO OFF (battery operation), see chpt. 6.4	AF	on	Automatic switch-off function after 3 min without load change ON
		off	Automatic switch-off function after 3 min without load change OFF
Zero tracking (see chap. 8.4.3)	tr	on	On
		off	Off
Selecting an adjustment weight (see chpt. 8.4.4)	CAL	100*	*model-dependent
		200*	
		300*	
Backlighting for display (CDE models only) , see chpt. 8.4.2	bL	on	Background illumination on
		off	Background illumination off
		CH	The background illumination will be switched off automatically 10 sec after having reached a stable weighing value.
Automatic reference optimisation (see chpt. 7.7.1)	OPti	on	On
		off	Off
Reset to default setting (see chpt. 8.4.5)	rSt	no	no
		yes	yes

8.4 Description of individual functions

8.4.1 Weighing units (Unit)

- ⇒ With the weighing scale switched off, press the **ON/OFF**- and **TARE**-key simultaneously until “**Unit**“ appears.
- ⇒ Confirm by pressing the **PRINT**-key; the currently set weighing unit appears.
- ⇒ Use the **10x**-button to select between the different units (see table).
- ⇒ By pressing the **PRINT** button the selected weighing unit is taken over.

	<i>Display</i>	<i>Conversion factor</i> <i>1 g =</i>
Gram	g	1.
Pound	lb	0.0022046226
Ounce	oz	0.035273962
Troy ounce	ozt	0.032150747
Tael Hongkong	tlh	0.02671725
Tael Taiwan	tlt	0.0266666
Grain	gn	15.43235835
Pennyweight	dwt	0.643014931
Momme	(mom)	0.2667
Tola	tol	0.0857333381
Carat	ct	5
Freely selectable factor *)	FFA	xx.xx

*)

In order to enter an own conversion factor, press the **10x**-button as explained above until „FFA“ is displayed. Confirm by pressing the **PRINT** key The last digit begins to flash. Using the **20x**-button, the displayed value is increased by 1, with the **5x**-button it is reduced by 1. Use the **TARE** button to jump one digit to the left. When all the changes are ready, use the **PRINT** button to save this value and by pressing the **PRINT** button the „Freely selectable factor“ is taken over as current weighing unit.

8.4.2 Backlighting of display (CDE models only)

In the menu the functions of the background illumination can be switched on or off. Proceed as follows:

- ⇒ With the weighing scale switched off, press **ON/OFF** and **TARE**-key simultaneously until the first function “Unit” appears.
- ⇒ Repeatedly press the **10x**-key until “bl”.
- ⇒ Confirm by pressing the **PRINT**-key. Current setting appears.
- ⇒ You can now use the **10x**-key, to select one of the three settings below:

Display	Adjustment	Function
„bl“ on	Background illumination on	Contrastful display which can also be red in the darkness.
„bl“ off	Background illumination off	Battery saving
„bl“ Ch	The background illumination will be switched off automatically 10 sec after having reached a stable weighing value.	Battery saving

- ⇒ Changed setting will be imported by pressing the **PRINT** key. The balance returns automatically into weighing mode.

8.4.3 Dosing and Zero-tracking

The Auto-Zero function is used to tare small variations in weight automatically. In the event that small quantities are removed or added to the material to be weighed, incorrect weighing results can be displayed due to the “stability compensation“ in the balance. (Example: Slowly draining fluids from a container on the balance.)

When apportioning involves small variations of weight, it is advisable to switch off this function.

If **Zero-Tracking** however is switched off, the weighing display becomes more busy.

- ⇒ With the weighing scale switched off, press **ON/OFF** and **TARE**-key simultaneously until the first function “**Unit**“ appears.
- ⇒ Repeatedly press the **10x**-key until “**tr**“ appears.
- ⇒ Confirm by pressing the **PRINT**-key. Current setting appears.
- ⇒ Now you can use the **10x**-key to select among the settings below:
 - „**tr on**“: Function activated
 - „**tr off**“: Function deactivated
- ⇒ Changed setting will be imported by pressing the **PRINT** key. The balance returns automatically into weighing mode.

8.4.4 Selection of the adjustment weight

For the model ranges **KERN CDE** and **CME** the adjustment weight can be selected from three or four preset nominal values (c. 1/3; 2/3; max or c. 1/4; 1/2; 3/4; max) (see also table 1 below, default settings are highlighted in grey). In order to achieve high-quality weighing results in the sense of the measuring technology, it is recommended to select the nominal value as high as possible.

- ⇒ With the weighing scale switched off, press **ON/OFF** and **TARE**-key simultaneously until the first function "**Unit**" appears.
- ⇒ Repeatedly press the **10x**-key until "**CAL**" appears.
- ⇒ Confirm by pressing the **PRINT**-key. Current setting appears.
- ⇒ Use the **10x**-key, to select among the preset nominal values (see tab. 1)
- ⇒ Confirm your selected setting by pressing the **PRINT**-key.

CME 100-3	CME 300-2	CME 1000-2	CME 3000-1	CME 6000-1
20 g	100 g	200 kg	1 kg	2 kg
50 g	200 g	500 kg	2 kg	5 kg
100 g	300 g	1000 kg	3 kg	6 kg

CDE 35K1	CDE 35K1L	CDE 60K2	CDE 60K2L	CDE 150K5	CDE 150K5L
5 kg	5 kg				
10 kg	10 kg	20 kg	20 kg	50 kg	50 kg
20 kg	20 kg	40 kg	40 kg	100 kg	100 kg
30 kg	30 kg	60 kg	60 kg	150 kg	150 kg

8.4.5 Reset to factory setting

With this function the manual changes of the menu settings are reset to factory setting.

- ⇒ With the weighing scale switched off, press **ON/OFF** and **TARE**-key simultaneously until the first function "**Unit**" appears.
- ⇒ Repeatedly press the **10x**-key until "**rSt**" appears.
- ⇒ Confirm by pressing the **PRINT**-key. Current setting appears.
- ⇒ Now you can use the **10x**-key to select among the settings below:
 - „**rSt** **no**“: No reset to default setting
 - „**rSt** **yes**“: Reset to default setting
- ⇒ Confirm your selected setting by pressing the **PRINT**-key.

9 Data output RS 232 C

9.1 Technical data

- 8-bit ASCII Code
- 1 start bit, 8 data bits, 1 stop bit, no parity bit
- Baud rate selectable at 1200, 2400, 4800, 9600 and 19200 Baud
- Miniature plug-in necessary (9 pole D-Sub)
- For operation with interface faultless operation is only ensured with the correct KERN – interface cable (max. 2m)

9.2 Pin allocation of the balance output socket (front view)

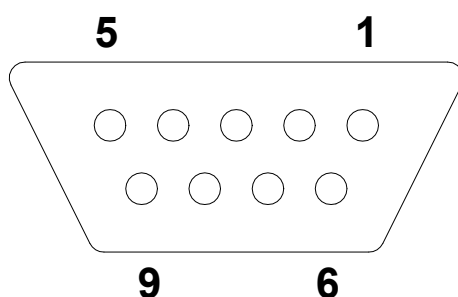

Pin 2: Transmit data
Pin 3: Receive data
Pin 5: Signal ground

9.3 Interface parameter

General Information

The previous condition for the data transfer between balance and a peripheral device (e.g. printer, PC) is that the appliances are set to the same interface parameters (e.g. baud rate, transfer mode).

9.3.1 Data transfer mode

- ⇒ With the weighing scale switched off, press **ON/OFF** and **TARE**-key simultaneously until the first function "**Unit**" appears.
- ⇒ Repeatedly press the **10x**-key until "**PR**" appears.
- ⇒ Confirm by pressing the **PRINT**-key. Current setting appears.
- ⇒ Now you can use the **10x**-key to select among the different settings (see chpt. 8.3)
- ⇒ Changed setting will be imported by pressing the **PRINT** key. The balance returns automatically into weighing mode.

9.3.2 Baud rate

The baud rate necessary for the measuring values transfer can be set. In the following example the baud rate is set to 9600 baud.

- ⇒ With the weighing scale switched off, press **ON/OFF** and **TARE**-key simultaneously until the first function "**Unit**" appears.
- ⇒ Repeatedly press the **10x**-key until "**bAUd**" appears.
- ⇒ Confirm by pressing the **PRINT**-key. Current setting appears.
- ⇒ Now you can use the **10x**-key to select among the different settings (see chpt. 8.3)
- ⇒ Changed setting will be imported by pressing the **PRINT** key. The balance returns automatically into weighing mode.

9.3.3 Selection printed edition

Use this function to select which data are sent via the RS232C interface. To achieve this, follow the sequence of operations below:

- ⇒ With the weighing scale switched off, press **ON/OFF** and **TARE**-key simultaneously until the first function "**Unit**" appears.
- ⇒ Repeatedly press the **10x**-key until "**LAPr**" appears.
- ⇒ Confirm by pressing the **PRINT** key.
- ⇒ Now you can use the **10x**-key to select among the output parameters below:

Display	Status	Function
„Hdr“	On / Off	Edition of the headlines
„GrS“	On / Off	Edition of the total weight
„Net“	On / Off	Edition of the net weight
„tAr“	On / Off	Edition of the tare weight
„N7E“	On / Off	Edition of the stored weight
„PCS“	On / Off	Edition of quantity
„AUJ“	On / Off	Edition of the unit weight
„rqt“	On / Off	Edition of the reference quantity
„FFd“	On / Off	Edition of a page feeding
„FFE“	On / Off	Edition of a page feeding at end printer output

- ⇒ Confirm selected parameter by pressing the **PRINT**-key; current setting appears.
- ⇒ Press the **10x**-key, to select “**on**” or “**off**”
- ⇒ Changed setting will be imported by pressing the **PRINT** key. The balance returns automatically into weighing mode.

By that way the user can configurate his own data block, which then is sent to a printer or to a PC.

9.4 Explanation of the data transfer

Pr PC:

Press the **PRINT** key, at stable weight the format is transferred from **LAPR**.

a. Format for stable values for weight/quantity/percentage

1	2	3	4	5	6	7	8	9	10	11	12	13	14	15	16	17	18
M	S	N ₁	N ₂	N ₃	N ₄	N ₅	N ₆	N ₇	N ₈	N ₉	N ₁₀	B	U ₁	U ₂	U ₃	CR	LF

b. Format in case of fault

1	2	3	4	5	6	7	8	9	10	11	12	13	14	15	16	17	18
B	B	B	B	B	B	B	B	B	B	B	E	r	r	o	r	CR	LF

AU Pr:

As soon as the weighing value is stable, the format is automatically transferred from **LAPR**.

c. Format for stable values for weight/quantity/percentage

1	2	3	4	5	6	7	8	9	10	11	12	13	14	15	16	17	18
M	S	N ₁	N ₂	N ₃	N ₄	N ₅	N ₆	N ₇	N ₈	N ₉	N ₁₀	B	U ₁	U ₂	U ₃	CR	LF

d. Format in case of fault

1	2	3	4	5	6	7	8	9	10	11	12	13	14	15	16	17	18
B	B	B	B	B	B	B	B	B	B	B	E	r	r	o	r	CR	LF

9.4.1 AU PC

The weighing values are sent automatically and continuously, no matter if the value is stable or unstable.

e. Format for stable values for weight/quantity/percentage

1	2	3	4	5	6	7	8	9	10	11	12	13	14	15	16	17	18
B*	B	B	B	B	B	B	B	B	0	.	0	B	g	B	B	CR	LF

f. Format in case of fault

1	2	3	4	5	6	7	8	9	10	11	12	13	14
B	B	B	B	B	B	B	E	r	r	o	r	CR	LF

g. Format for unstable values for weight/quantity/percentage

1	2	3	4	5	6	7	8	9	10	11	12	13	14	15
B*	B	B	B	B	B	B	B	B	0	.	0	B	CR	LF

rE Cr:

The remote control commands s/w/t are sent from the remote control unit to the balance as ASCII code. After the balance having received the s/w/t commands, it will send the following data.

Take into account that the following remote control commands must be sent without a subsequent CR LF.

- s** Function: Stable weighing value for the weight is sent via the RS232 interface
- w** Function: Weighing value for the weight (stable or unstable) is sent via the RS232 interface
- t** Function: No data are sent, the balance carries out the tare function.

h. Format for stable values for weight/quantity/percentage

1	2	3	4	5	6	7	8	9	10	11	12	13	14	15	16	17	18
M	S	N ₁	N ₂	N ₃	N ₄	N ₅	N ₆	N ₇	N ₈	N ₉	N ₁₀	B	U ₁	U ₂	U ₃	CR	LF

i. Format in case of fault

1	2	3	4	5	6	7	8	9	10	11	12	13	14	15	16	17	18
B	B	B	B	B	B	B	B	B	B	B	E	r	r	o	r	CR	LF

j. Format for unstable values for weight/quantity/percentage

1	2	3	4	5	6	7	8	9	10	11	12	13	14	15	16	17	18
M	S	N ₁	N ₂	N ₃	N ₄	N ₅	N ₆	N ₇	N ₈	N ₉	N ₁₀	B	B	B	B	CR	LF

Symbols

M	Blank or M
S	Blank or minus sign (-)
N ₁ ... N ₁₀	10 numeric ASCII codes for weight values including decimal places or blanks
U ₁ ... U ₃	3 ASCII codes for weighing unit pcs. / % / or blank
B	Blank
E, o, r	ASCII code or "E, o, r"
CR	Carriage Return
LF	Line Feed

9.5 Output on bar code printer

The data transfer mode has to be set on „**BA Pr**“.

As bar code printer the Zebra printer model LP2824 is provided.

Take into account that the output format of the balance is fixedly defined and cannot be changed.

The printer format is stored in the printer, i.e. in case of a failure the printer cannot be changed with a new one from factory, previously it is necessary that KERN installs the respective software.

The Zebra printer and the balance must be connected to the delivered interface cable when they are switched off.

After switching-on both appliances, and after reaching the status ready-for-operation, a label will be printed out when pressing the **PRINT** button.

10 Service, maintenance, disposal

10.1 Cleaning

Before cleaning, please disconnect the appliance from the operating voltage.

Please do not use aggressive cleaning agents (solvents or similar agents), but a cloth dampened with mild soap suds. Ensure that no liquid penetrates into the device and wipe with a dry soft cloth.

Loose residue sample/powder can be removed carefully with a brush or manual vacuum cleaner.

Spilled weighing goods must be removed immediately.

10.2 Service, maintenance

The appliance may only be opened by trained service technicians who are authorized by KERN. Before opening, disconnect from power supply.

10.3 Disposal

Disposal of packaging and appliance must be carried out by operator according to valid national or regional law of the location where the appliance is used.

11 Instant help

In case of an error in the program process, briefly turn off the balance and disconnect from power supply. The weighing process must then be restarted from the beginning.

Help:

Fault

Possible cause

- | | |
|--|--|
| The displayed weight does not glow. | <ul style="list-style-type: none">• The balance is not switched on.• The mains supply connection has been interrupted (mains cable not plugged in/faulty).• Power supply interrupted. |
| The displayed weight is permanently changing | <ul style="list-style-type: none">• Draught/air movement• Table/floor vibrations• The weighing plate is in contact with foreign matter.• Electromagnetic fields / static charging (choose different location/switch off interfering device if possible) |
| The weighing value is obviously wrong | <ul style="list-style-type: none">• The display of the balance is not at zero• Adjustment is no longer correct.• Great fluctuations in temperature.• Electromagnetic fields / static charging (choose different location/switch off interfering device if possible) |

Should other error messages occur, switch balance off and then on again. If the error message remains inform your specialist dealer.

12 Counting system CDEE

12.1 Introduction

A counting system allows the construction of a dual balance assembly for piece counting.

The **KERN Scale CDE** is used as quantity scale for the determination of the piece number/piece weight.

The high resolution of Kern scale **KERN CME** allows a very precise determination of the reference weight for items of low weight.

The weight of quantity must be determined till to the maximum of the CME on the reference balance.

If the value is $>$ max of the CME, the CDE can be used.

Information:

User instructions for the counting system are given below. A detailed description of the weighing scale's operation can be found in the previous chapters.

12.2 Technical data

Counting system	Quantity scale			Reference scale			
	KERN	Weighing range (max) kg	Legibility (d) g	KERN	Weighing range (max) g	Legibility (d) g	Minimum piece weight g/item
CDEE 35K0.001	CDE 35K1	35	1	CME 100-3	100	0,001	0,002
CDEE 35K0.01	CDE 35K1	35	1	CME 300-2	300	0,01	0,02
CDEE 35K0.01L	CDE 35K1L	35	1	CME-300-2	300	0,01	0,02
CDEE 60K0.01	CDE 60K2	60	2	CME 300-2	300	0,01	0,02
CDEE 60K0.01L	CDE 60K2L	60	2	CME 300-2	300	0,01	0,02
CDEE 150K0.1	CDE 150K5	150	5	CME 3000-1	3000	0,1	0,2

12.3 Basic structure

The counting system consists of the following components:

- Quantity scale **KERN CDE**
- Reference scale **KERN CME**
- Interface cable **CDE-A01**

12.4 Installation

- Switch off both scales and disconnect
- Connect both scales with the data cable provided for the RS232 interface

12.5 Balance settings

To enable automatic transfer of the reference weight from CME to CDE, the data transfer mode “Pr” in the menu (see chpt.9.3.1) must be set to “CSyS”.

12.6 Counting with both scales



Attention:

To prevent errors during the piece count determination, both scales must be adjusted to the same gravity acceleration (see chap. 6.8). Non-compliance will result in counting errors!

1. Place empty vessel on weighing platform of quantity scale **KERN CDE** and tare by pressing the key (TARE)
2. Place reference piece number of count quantity on reference scale **KERN CME** (e.g. 5, 10, 20 items)
3. Confirm selected reference piece number by pressing the key (5, 10, 20) on the reference scale.
4. Fill vessel on quantity scale with count quantity. The piece number is shown directly on the display. The -key may be used to switch over to piece weight.